

Artech Quadrus Recessed LED Luminaire

Architectural linear LED system for Recessed application. Total luminous flux up to 200 lm with overall luminaire efficacy of 91 lm/W. Supplied with fixed output or DALI digital dimmable driver, optional - basic 3hr, self-test or EMPRO emergency kit. Aluminum extruded body in white or black finish. Beam angle available 15, 30 or 40 Degree.

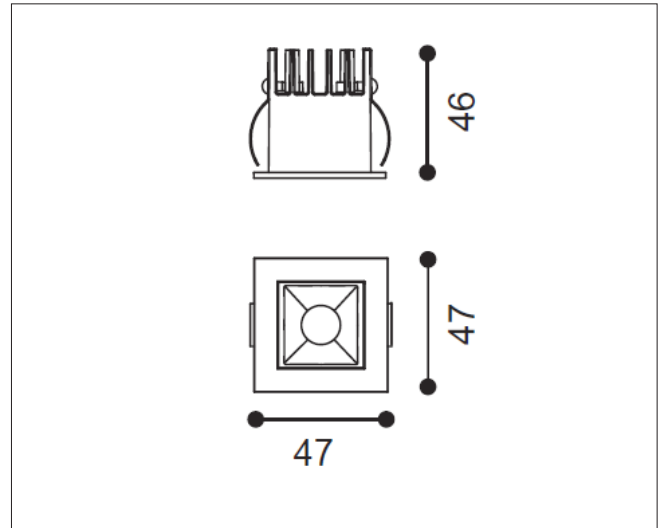

Mounting	Recessed (With Trim)
Lamp Type	LED
Wattage	2.2 W
Lumen Output	200 lm
Efficacy	91 lm/W
Colour Temperature	3000 K
CRI	90+
Beam Angle	40°
IP Rating	IP20
Control Gear	Fixed Output
Dimensions	47 x 47 x 46 mm
Colour Finish	White/Black
MacAdam	3
Service Lifetime	L80/B10 55,000 Hrs

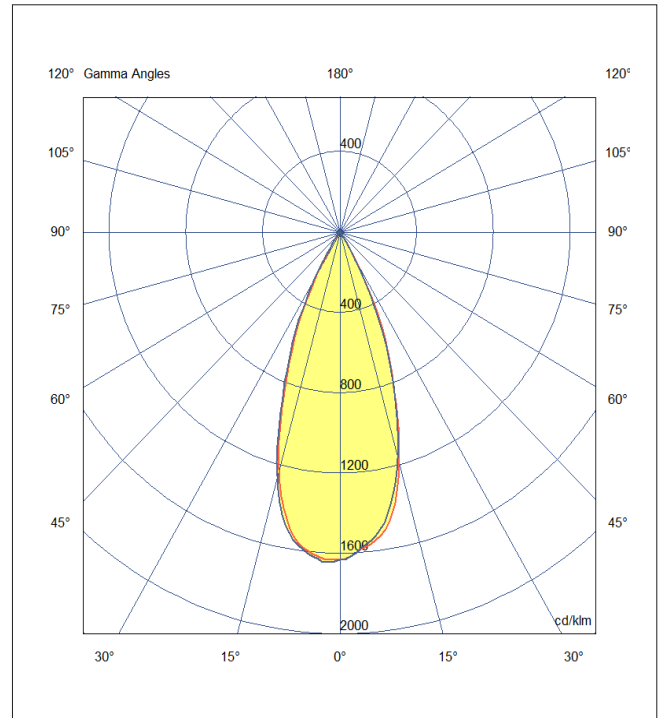

powered by

TRIDONIC

Driver details available upon request