

### Artech Quadrus Recessed LED Luminaire

Architectural linear LED system for Recessed application. Total luminous flux up to 3000 lm with overall luminaire efficacy of 91 lm/W. Supplied with fixed output or DALI digital dimmable driver, optional - basic 3hr, self-test or EMPRO emergency kit. Aluminum extruded body in white or black finish. Beam angle available 15, 30 or 40 Degree.

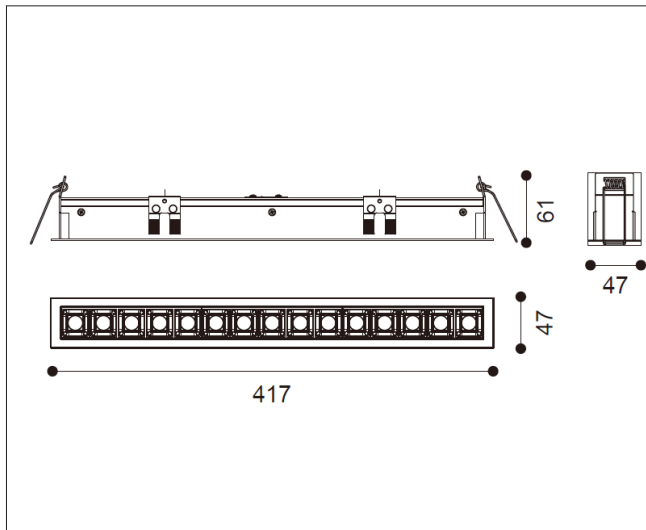

<b>Mounting</b>	Recessed (With Trim)
<b>Lamp Type</b>	LED
<b>Wattage</b>	33 W
<b>Lumen Output</b>	3000 lm
<b>Efficacy</b>	91 lm/W
<b>Colour Temperature</b>	3000 K
<b>CRI</b>	90+
<b>Beam Angle</b>	30°
<b>IP Rating</b>	IP20
<b>Control Gear</b>	Fixed Output
<b>Dimensions</b>	417 x 47 x 61 mm
<b>Colour Finish</b>	White/Black
<b>MacAdam</b>	3
<b>Service Lifetime</b>	L80/B10 55,000 Hrs

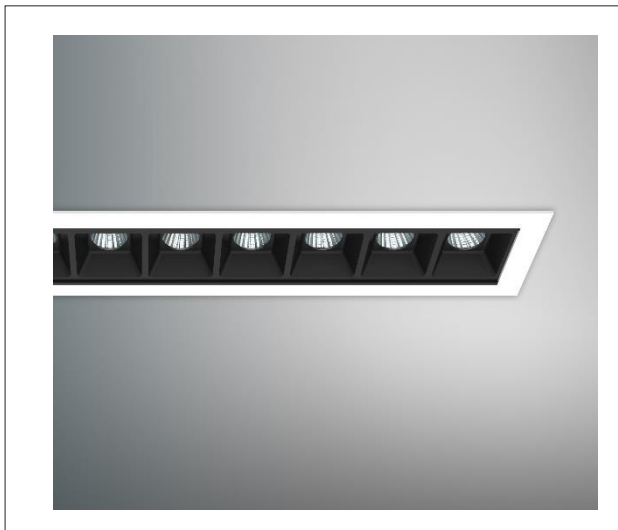
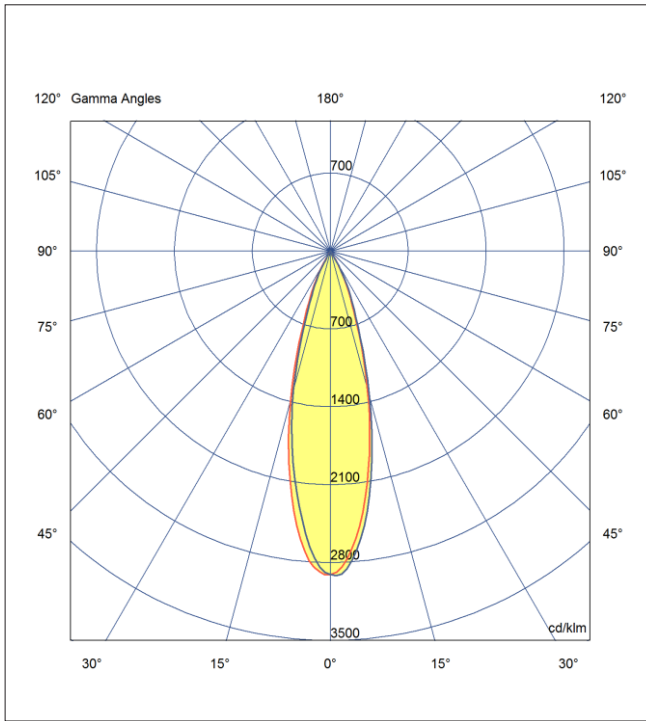

powered by

# TRIDONIC

Driver details available upon request