

Artech Quadrus Tilt Recessed LED Luminaire

Architectural linear LED system for Recessed application. Total luminous flux up to 2000 lm with overall luminaire efficacy of 91 lm/W. Supplied with fixed output or DALI digital dimmable driver, optional - basic 3hr, self-test or EMPRO emergency kit. Aluminum extruded body in white or black finish. Beam angle available 15, 30 or 40 Degree.

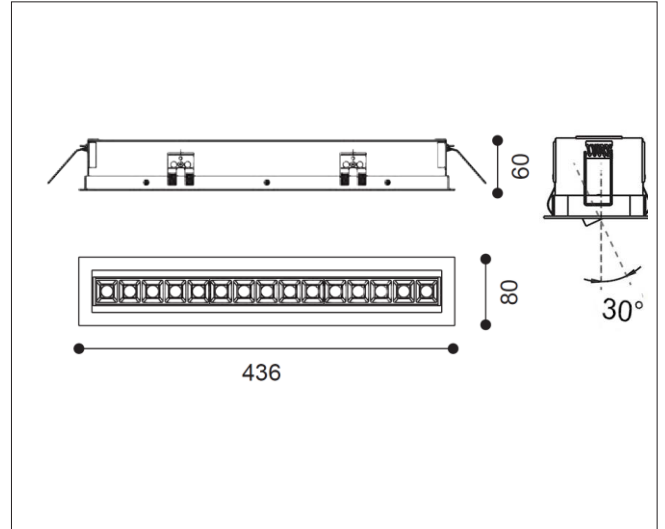

| | |
|---------------------------|----------------------|
| Mounting | Recessed (With Trim) |
| Lamp Type | LED |
| Wattage | 33 W |
| Lumen Output | 3000 lm |
| Efficacy | 91 lm/W |
| Colour Temperature | 3000 K |
| CRI | 90+ |
| Beam Angle | 40° |
| IP Rating | IP20 |
| Control Gear | Fixed Output |
| Dimensions | 436 x 80 x 60 mm |
| Colour Finish | White/Black |
| MacAdam | 3 |
| Service Lifetime | L80/B10 55,000 Hrs |

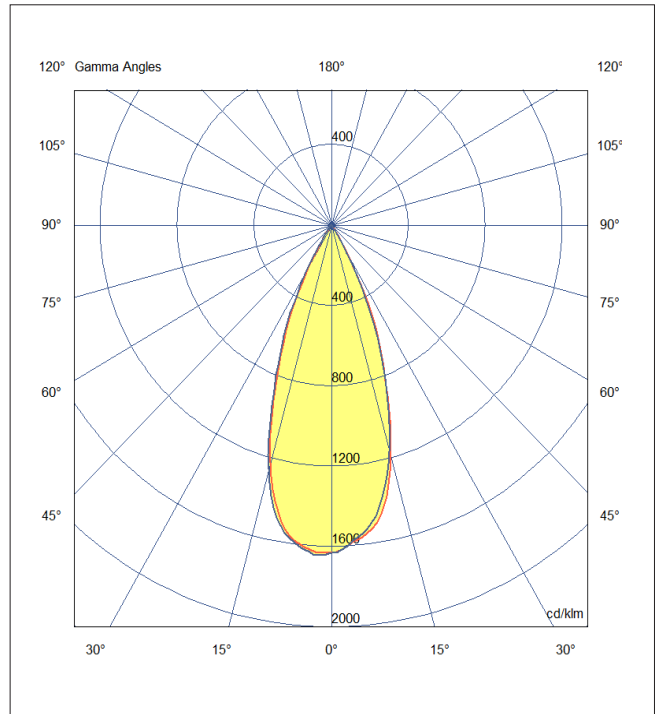

powered by

TRIDONIC

Driver details available upon request