

# TENUS ROUND SNOOT

TRN 05 30 12 CL 85 ST WWB



## Artech Tenus Round Snoot Fixed Downlight

Artech Tenus recessed architectural fixed LED downlight with ingress protection IP44. Total luminous flux up to 500 lm with overall luminaire efficacy of 79 lm/W. Supplied with fixed output, DALI digital or phase-cut dimmable driver, optional 3 -hour Basic or EMPRO emergency kit. Forged aluminum heat sink with die-cast white or black bezel.

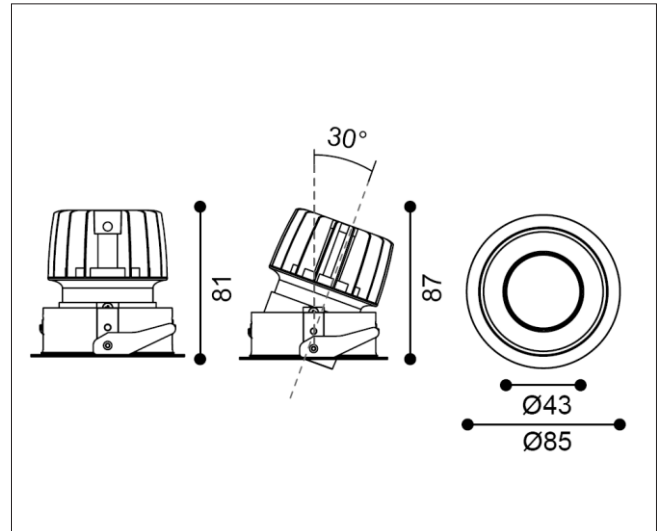

<b>Mounting</b>	Recessed With Trim
<b>Lamp Type</b>	LED
<b>Wattage</b>	6.3 W
<b>Lumen Output</b>	500 lm
<b>Efficacy</b>	79 lm/W
<b>Colour Temperature</b>	3000 K
<b>CRI</b>	90+
<b>Beam Angle</b>	12°
<b>IP Rating</b>	IP44
<b>Control Gear</b>	Fixed Output
<b>Dimensions</b>	85 Dia x 87 mm
<b>Colour Finish</b>	White/ White/ Black
<b>MacAdam</b>	3
<b>Service Lifetime</b>	L80/B10- 55,000 Hrs

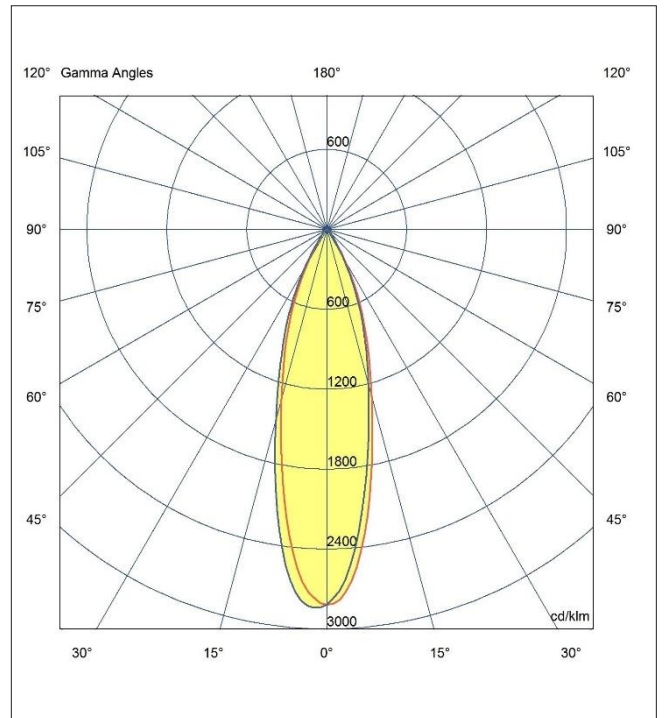

powered by

**TRIDONIC**

Driver details available upon request



Artech lighting strives to ensure all solutions are supplied with the latest technology, we therefore reserve the right to make technical and design changes without prior notice. Electrical connected load and luminous flux are subject to initial tolerance of up +/- 10%. Colour Temperature is subject to a tolerance of +/-150 Kelvin

St.JohnsRd,MeadowfieldIndustrialEstate,Durham,Co.Durham,DH78RJ -UnitedKingdom |T:+44(0)1913787960-F:+44(0)1913787909-www.artechlighting.com

