

# PROLIGHT ECO

APE 13 50 PC A S

ARTECH  
LIGHTING

## Artech Prolight Eco Surface Mounted Luminaire

Artech Prolight Eco architectural LED luminaire with ingress protection IP65. Total luminous flux up to 1260 lm with overall luminaire efficacy up to 105 lm/W. Supplied with fixed output, or optional 3 – hour basic emergency kit. Steel housing with polycarbonate diffuser.

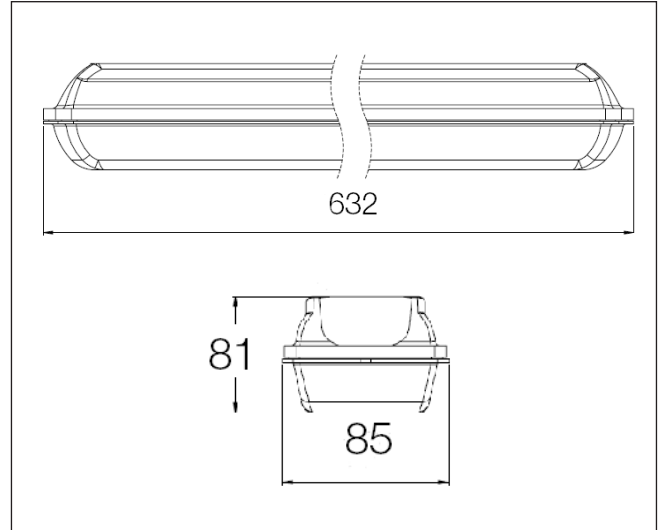

<b>Mounting</b>	Surface
<b>Lamp Type</b>	LED
<b>Wattage</b>	12 W
<b>Lumen Output</b>	1260 lm
<b>Efficacy</b>	105 lm/W
<b>Colour Temperature</b>	5000 K
<b>CRI</b>	80+
<b>Optic</b>	Polycarbonate Diffuser
<b>IP Rating</b>	IP65
<b>Control Gear</b>	Fixed Output
<b>Dimensions</b>	632 x 85 x 81 mm
<b>Colour Finish</b>	White
<b>MacAdam</b>	3
<b>Service Lifetime</b>	L80/B10-50,000 Hrs

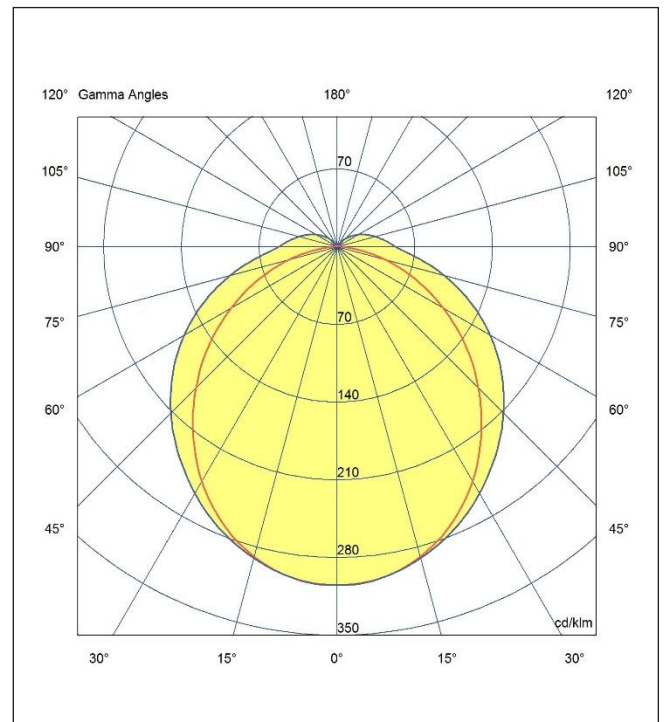

Artech lighting strives to ensure all solutions are supplied with the latest technology, we therefore reserve the right to make technical and design changes without prior notice. Electrical connected load and luminous flux are subject to initial tolerance of up +/- 10%. Colour Temperature is subject to a tolerance of +/-150 Kelvin

St.JohnsRd, Meadowfield Industrial Estate, Durham, Co. Durham, DH78RJ-United Kingdom | T: +44(0)1913787960-F: +44(0)1913787909-www.artechlighting.com

