

Part Code: **QUF 200 40 40 10 S WW**

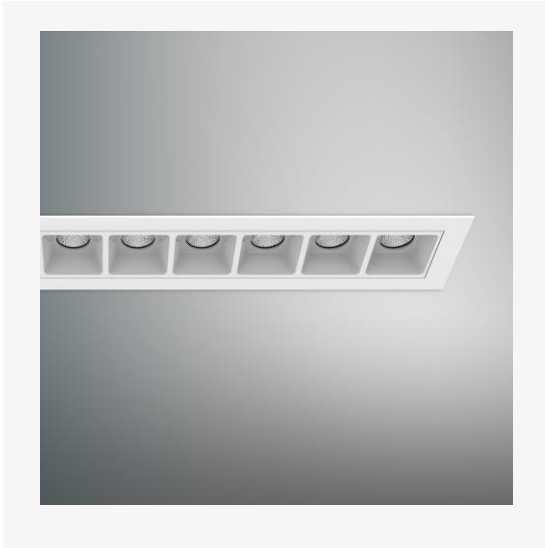

Architectural linear LED system for Surface application. Total luminous flux up to 2000 lm with overall luminaire efficacy of 91 lm/W. Supplied with fixed output or DALI digital dimmable driver, optional - basic 3hr, self-test or EMPRO emergency kit. Aluminum extruded body in white or black finish. Beam angle available 15, 30 or 40 Degree.

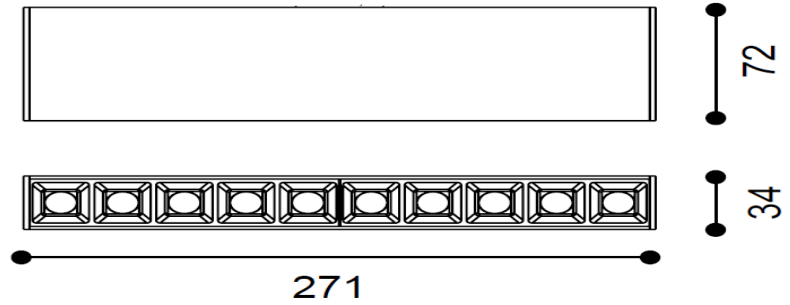

Production Information

Physical
 Mounting Type – Surface
 Length – 285mm
 Height – 90mm
 Width – 47mm
 Finish – White/White
 IP Rating – IP20

Electrical
 Lamp Type – LED
 Wattage – 22 W
 Efficacy – 91lm/W
 Driver – Tridonic/Forge
 Control – Fixed Output

LED
 Delivered lumen output – 2000lm
 CCT – 4000K
 CRI – 90+
 MacAdam – < 3
 Service Lifetime – L80/B10 55,000hrs

Optic
 40° Beam Angle

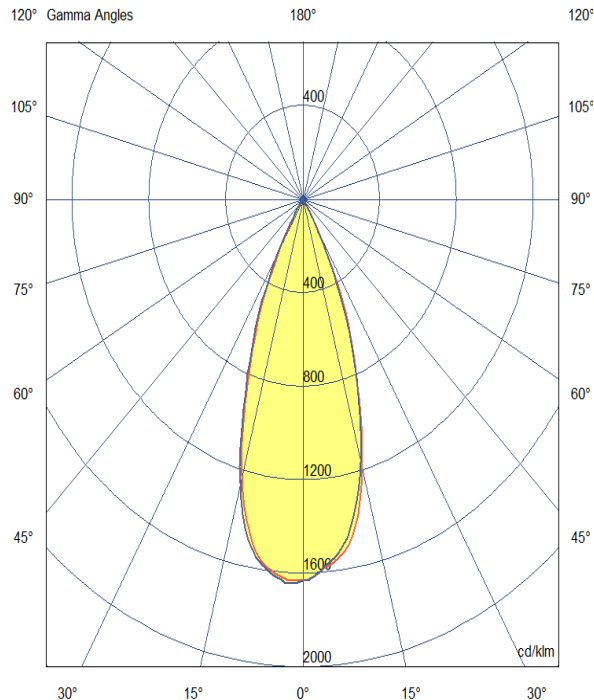

Artech lighting strives to ensure all solutions are supplied with the latest technology, we therefore reserve the right to make technical and design changes without prior notice. Electrical connected load and luminous flux are subject to initial tolerance of up +/- 10%. Colour Temperature is subject to a tolerance of +/-150 Kelvin.

St Johns Rd, Meadowfield Ind. Estate, Durham, Co. Durham, DH7 8RJ, United Kingdom
T: +44(0) 191 3787960 E: info@artechlighting.com

Powered by:

