

MAGNA HYBRID

ARTECH
LIGHTING

Part Code: **MHM 78 30 24 MD**



Artech Magna LED module, with high quality injection moulded TIR optic, COB LED, and extruded aluminium heatsink. Various lumen outputs, beam angles and colour temperatures available. 50mm diameter housing. High luminous efficacy up to 85 lm/W.

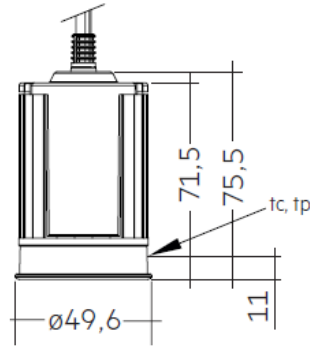

Production Information

Physical

Height – 75.5mm
Diameter – 50mm

Electrical

Lamp Type - LED
Wattage – 9.8 W
Efficacy – 80lm/W
Control – Mains Dimmable

LED

Manufacturer – Tridonic
LED Type – Modula SLA DC G2
Delivered lumen output –780lm
CCT – 3000K
CRI – 80+
MacAdam – <3
Service Lifetime – L80/B10 - 50,000Hrs

Optic

24° Clear

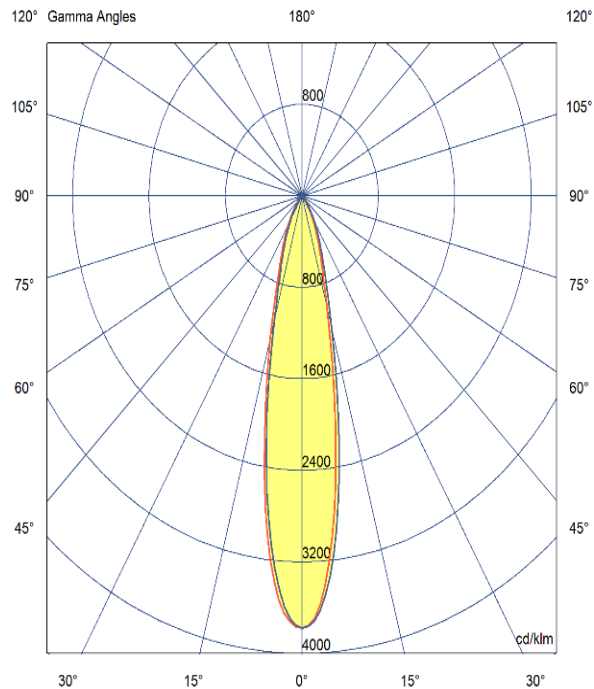

Artech lighting strives to ensure all solutions are supplied with the latest technology, we therefore reserve the right to make technical and design changes without prior notice. Electrical connected load and luminous flux are subject to initial tolerance of up +/- 10%. Colour Temperature is subject to a tolerance of +/-150 Kelvin.

St Johns Rd, Meadowfield Ind. Estate, Durham, Co. Durham, DH7 8RJ, United Kingdom
T: +44(0) 191 3787960 E: info@artechlighting.com

MADE IN
BRITAIN UK
CA